

BROTHER® HL-4150 SERIES TN310 • 315 TONER CARTRIDGE REMANUFACTURING INSTRUCTIONS



BROTHER® TN315 TONER CARTRIDGE

REMANUFACTURING THE BROTHER HL-4150 SERIES TN310/315 COLOR TONER CARTRIDGES

By Mike Josiah and the Technical Staff at UniNet

The Brother HL-4150 printer engine is based on a new 25-30 ppm black and color, 2400 x 600 DPI color LED engine. The machines come standard with 128Mb expandable to 384Mb of memory, and all run off a 400 MHz processor. All models come standard with duplex built in, and some have wireless interfaces. With print speeds of up to 30ppm and street pricing starting at \$289.00 USD*, these machines have become very popular.

***Pricing in U.S. American Dollars.**

The toner cartridges do not have a reset chip on them, but they do have a reset gear that must be positioned properly for the machine to accept it as a new cartridge. The proper reset position of the gear will be covered later in this instruction. The gears themselves can be a bit confusing as there are different configurations worldwide. Basically it comes down to this. For "high yield" cartridges (3.5 or 4K, color or black), use a gray reset gear. For "extra high yield" cartridges (6K, color or black), use a black reset gear. Starter cartridges are considered to be a "standard yield" and do not come with a reset gear. Any starter cartridge can be converted to a high yield or extra high yield cartridge. In different areas of the world, different yields are available; so there is not a separate color reset gear, nor a separate black reset gear. Below is a chart of which cartridges are used in what location, the part numbers, and yield. The gear that should be used for each is indicated by the yield.

NORTH, SOUTH & CENTRAL AMERICA REGION (USA BROTHER.COM)

| | | | |
|------------------|-------|---------------------|-------------|
| Standard Yield | TN310 | Cyan/Yellow/Magenta | 1,500 pages |
| Standard Yield | TN310 | Black | 2,500 pages |
| High Yield | TN315 | Cyan/Yellow/Magenta | 3,500 pages |
| Extra High Yield | TN315 | Black | 6,000 pages |

EUROPE REGION (GERMANY BROTHER.COM)

| | | | |
|------------------|-------|---------------------------|-------------|
| Standard Yield | TN320 | Black | 2,500 pages |
| Standard Yield | TN320 | Cyan/Yellow/Magenta | 1,500 pages |
| High Yield | TN325 | Black | 4,000 pages |
| High Yield | TN325 | Cyan/Yellow/Magenta | 3,500 pages |
| Extra High Yield | TN328 | Black/Cyan/Yellow/Magenta | 6,000 pages |

ASIA & OCEANIA REGION (HK BROTHER.COM)

| | | | |
|------------------|-------|---------------------------|-------------|
| Standard Yield | TN340 | Black | 2,500 pages |
| High Yield | TN345 | Cyan/Yellow/Magenta | 3,500 pages |
| Extra High Yield | TN348 | Black/Cyan/Yellow/Magenta | 6,000 pages |

ASIA & OCEANIA REGION (AUSTRALIA BROTHER.COM)

| | | | |
|------------------|-------|---------------------------|-------------|
| Standard Yield | TN340 | Black | 2,500 pages |
| Standard Yield | TN340 | Cyan/Yellow/Magenta | 1,500 pages |
| Extra High Yield | TN348 | Black/Cyan/Yellow/Magenta | 6,000 pages |

JAPAN REGION (JAPAN BROTHER.COM)

| | | | |
|----------------|-------|---------------------|-------------|
| Standard Yield | TN390 | Black | 2,500 pages |
| Standard Yield | TN390 | Cyan/Yellow/Magenta | 1,500 pages |
| High Yield | TN395 | Black | 4,000 pages |
| High Yield | TN395 | Cyan/Yellow/Magenta | 3,500 pages |

MIDDLE EAST (UNITED ARAB BROTHER.COM)

| | | | |
|------------------|-------|---------------------------|-------------|
| Standard Yield | TN340 | Black | 2,500 pages |
| Standard Yield | TN340 | Cyan/Yellow/Magenta | 1,500 pages |
| High Yield | TN345 | Cyan/Yellow/Magenta | 3,500 pages |
| Extra High Yield | TN348 | Black/Cyan/Yellow/Magenta | 6,000 pages |

When the printer senses a new toner cartridge, the bias voltage is set to a high voltage. As the cartridge is used, the bias voltage is gradually reduced. This process is necessary because according to Brother, a new toner cartridge has a tendency to print light. As the cartridge is used, the density increases (lower voltage = higher density). To keep the density level even throughout its life, the density bias voltage is reduced accordingly. Each time a new cartridge is installed, the reset gear engages the gear train. The rib on the reset gear pushes down on the new toner sensor. The bias voltage is then reset, and the cartridge page count is reset to zero. High yield cartridges have different stages set for the bias voltage than an extra high yield cartridge does. That's why there are two different gears.

While the cartridge yield is stated in pages printed, it actually is based on the revolutions of the developer roller. The larger the run, the better the yield. There are roller cycles for every print job and automatic ones, too. There is the warm-up cycle, color registration cycle, developer bias cycle, etc. As these cycles are normally run once per job, the bigger the print job, the better the yield. There are multiple revolutions for each cycle and some will run upon turning the printer on or opening the front cover. They can range from 35 rotations to as much as 262 rotations for each function so you can see how they can add up quickly. Brother has charts that cover different sized print jobs and how they relate to the total effective yield.

CURRENT MACHINES RELEASED SO FAR

HL-4140CN

HL-4150CDN

HL-4570CDW

HL-4570CDWT

MFP-9460CDN

MFP-9560CDW

MFP-9970CDW

OTHER CONSUMABLES USED IN THESE MACHINES

| | | |
|-----------------|------------------------|---------------------|
| DR-310CL | Drum unit | 25,000 pages |
| BU-300CL | Belt unit | 50,000 pages |
| WT-300CL | Waste toner box | 50,000 pages |

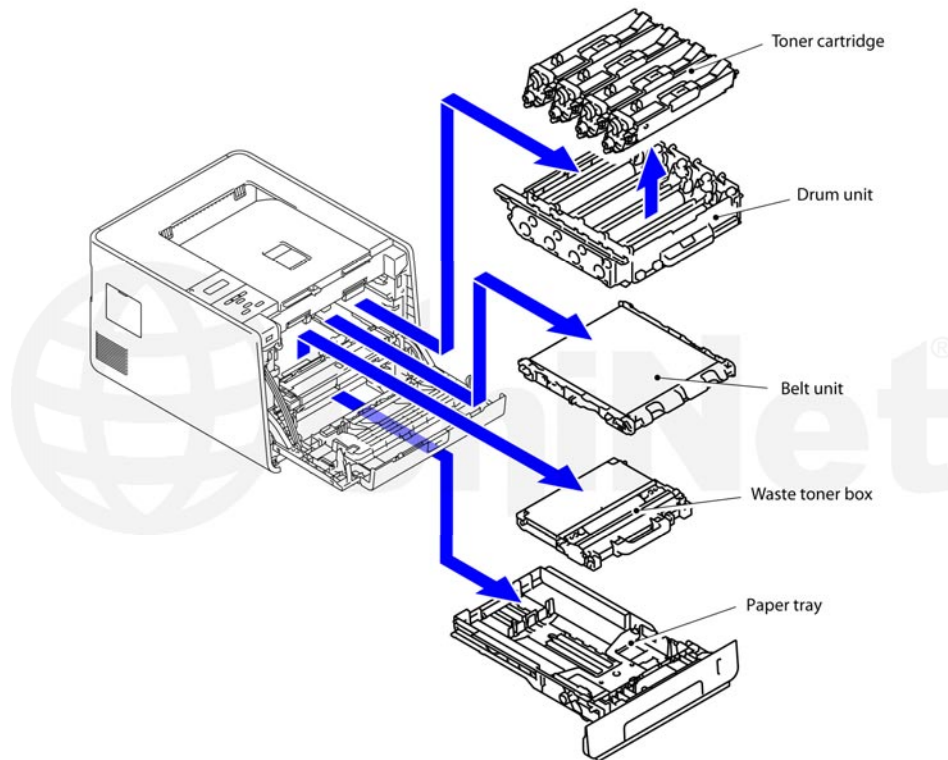
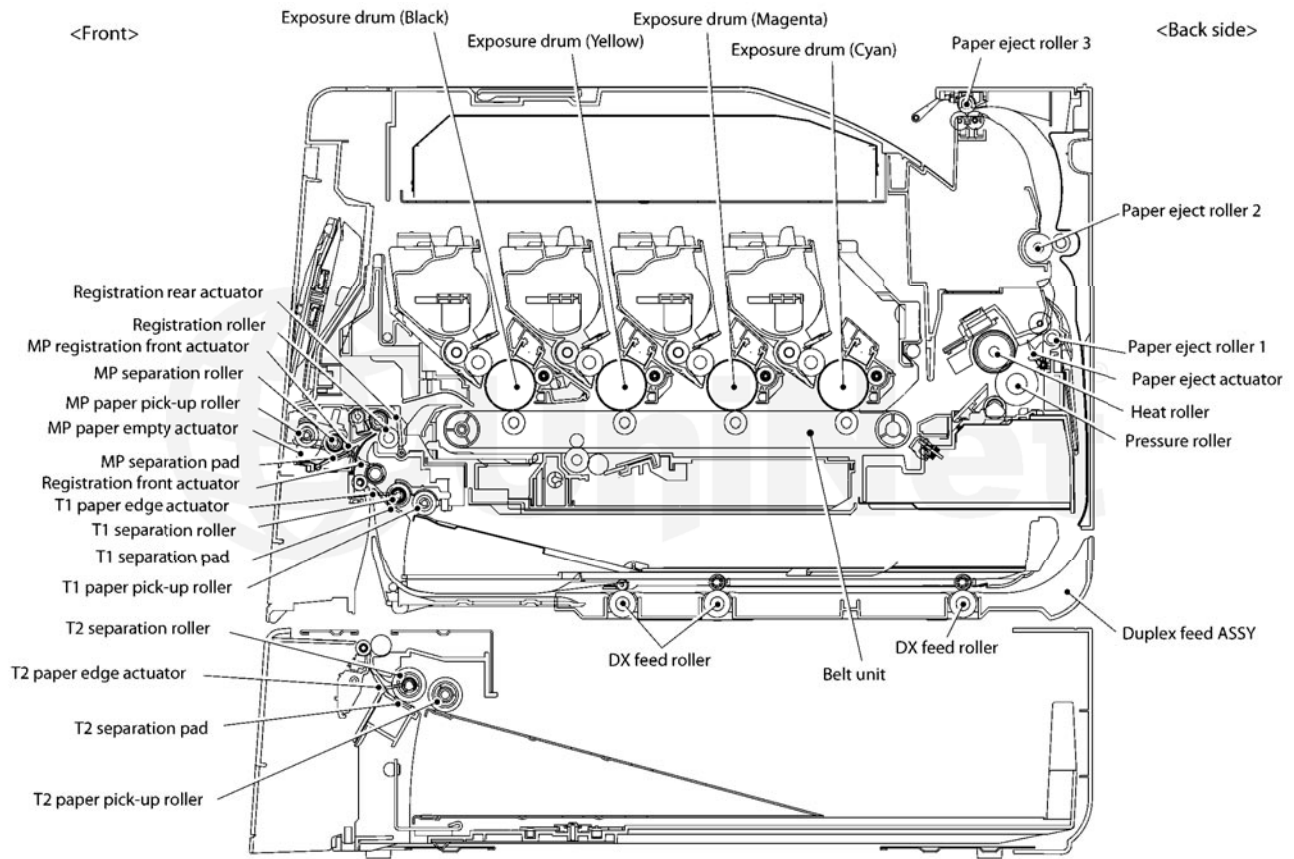

Shown here is a broad overview of the printing process and the different component locations.

As you can see these machines use a single-pass type system.

How to run test pages and cartridge troubleshooting will be covered at the end of this article.

REQUIRED TOOLS

1. Toner approved vacuum
2. Phillips head screwdriver
3. Small jewelers type common screwdriver

REQUIRED SUPPLIES

1. Replacement toner for use in Brother HL-4150 (choose the correct color and gram weight for your cartridge)
2. Replacement reset gear for use in the starter cartridge (see previous text)
3. Lint-free cotton cloths

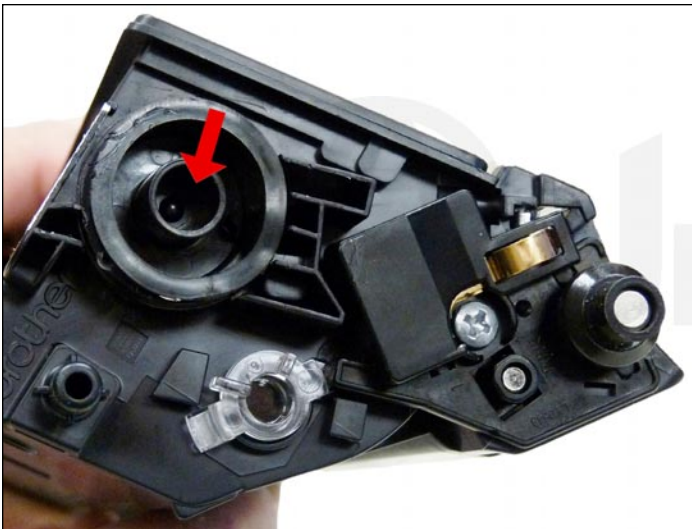

1. Vacuum the exterior of the cartridge. Be careful not to damage the developer roller, as it is exposed. Remove the fill plug from the toner cartridge. Dump the remaining toner and vacuum/blow out the cartridge. There will probably be a label over the fill plug. It comes off with a little alcohol and a lint free cloth or cotton swab.

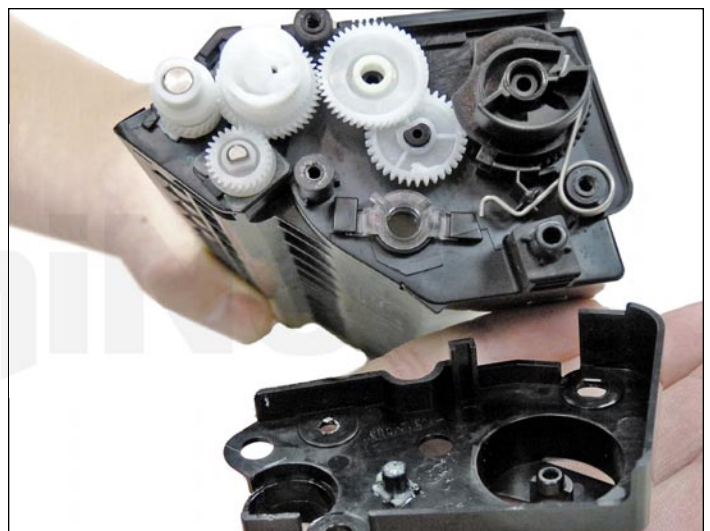
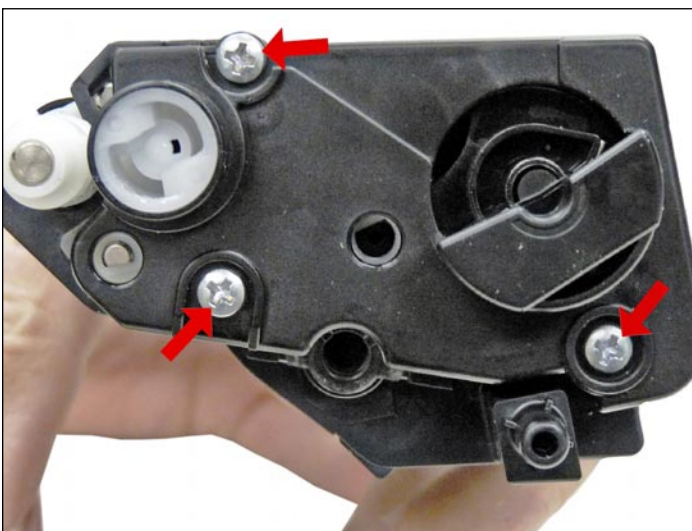

2. Remove the three screws on the left (gear side) end cap.

3. Remove the end cap.



4. Pry off the white developer roller bushing.

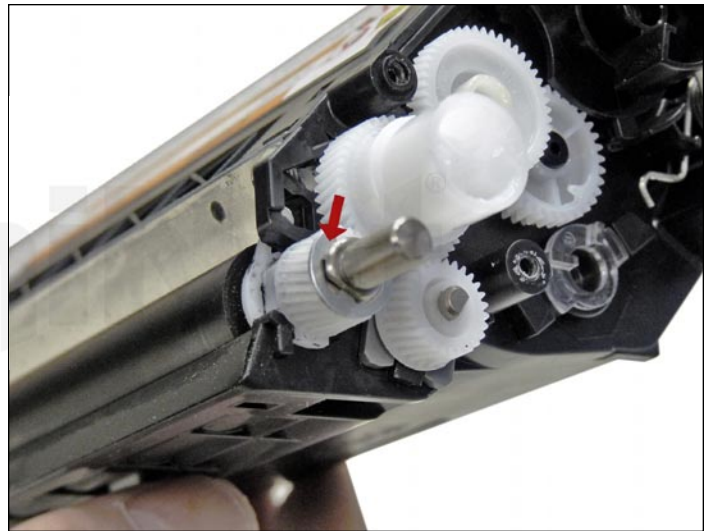

5. Remove the E-ring.

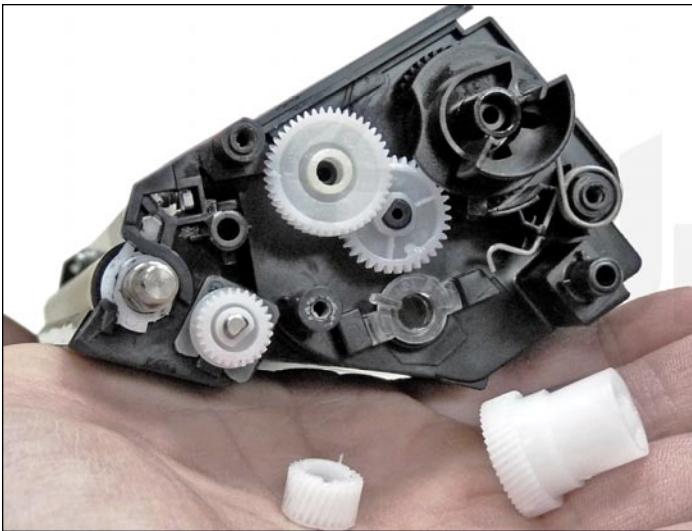

6. Remove the large white drive gear and the developer roller gear.



7. Remove the reset gear and spring.



8. Remove the three remaining small white gears.

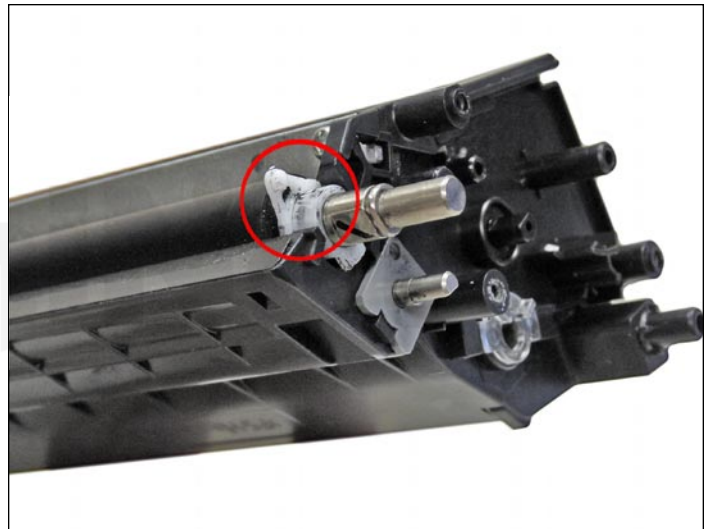

9. Move the white plastic locking tab on the right side of the developer roller to the up position.



10. Gently pry off the black bushing on the opposite side of the developer roller. Be careful not to lose the spring!

UniNet®

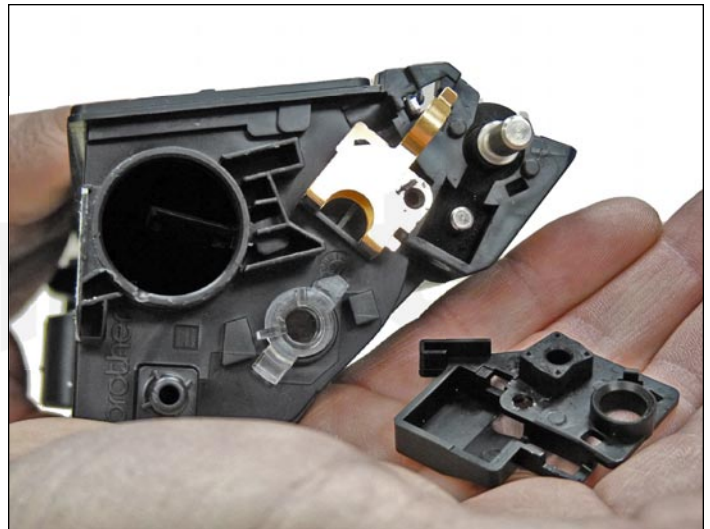

11. Remove the screw and contact side end cap for the developer roller.



12. Carefully remove the copper contact.



13. Remove the developer roller.



14. Carefully vacuum/blow the cartridge clean. Note the tape on the middle of the blade to keep it flat. Use only low-pressure air (using high-pressure air can cause leaks in the seals)! Be sure to rotate the foam feed-roller so it is fully cleaned.

Vacuum/blow the doctor blade. We do not recommend that the doctor blade be removed, as the developer roller felt seals would be disturbed. Once a new replacement blade is available, great care will have to be taken not to tear the seals, causing a leak. The doctor blade can be easily cleaned by blowing off the excess toner, and wiping down with a lint-free cloth. Be very careful not to leave any lint behind and do not use any chemicals to clean it!

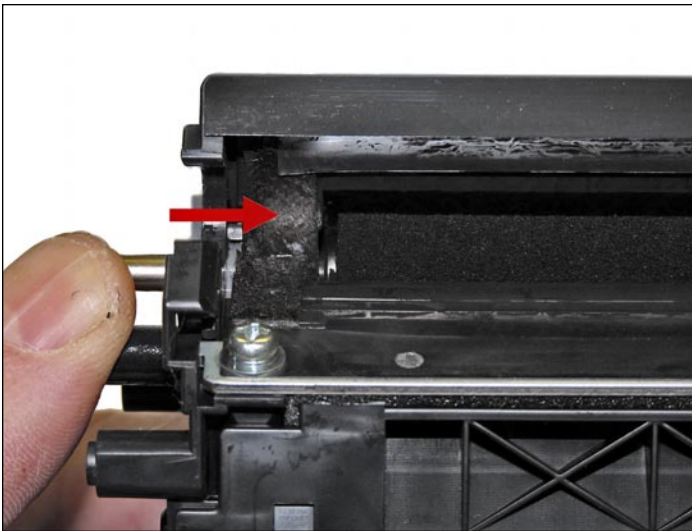

15. Inspect the developer roller felts. If they are compressed (shiny), gently rough them up with a small screwdriver.

UniNet®

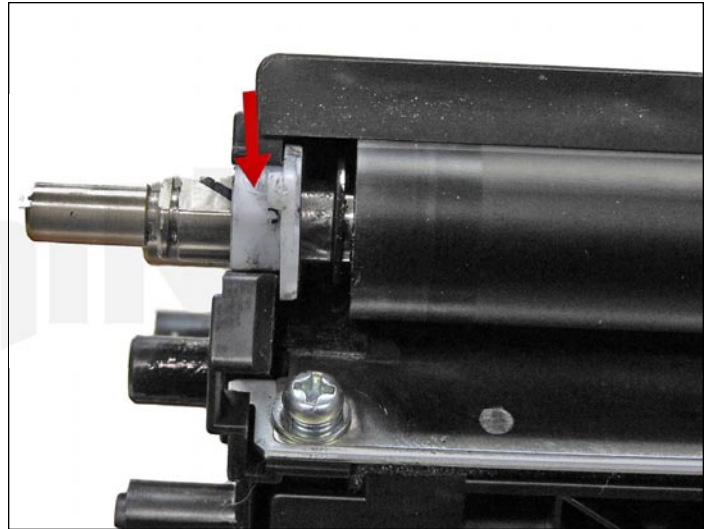

16. Clean the developer roller with a lint-free cloth. Do not use any chemicals to clean the roller. A dry, clean, lint-free cloth will work fine. Re-install the developer roller (keyed end to the gear side, and white lock pointing up). Make sure the white lock fits into the groove. Turn the lock towards the doctor blade until it locks in place.

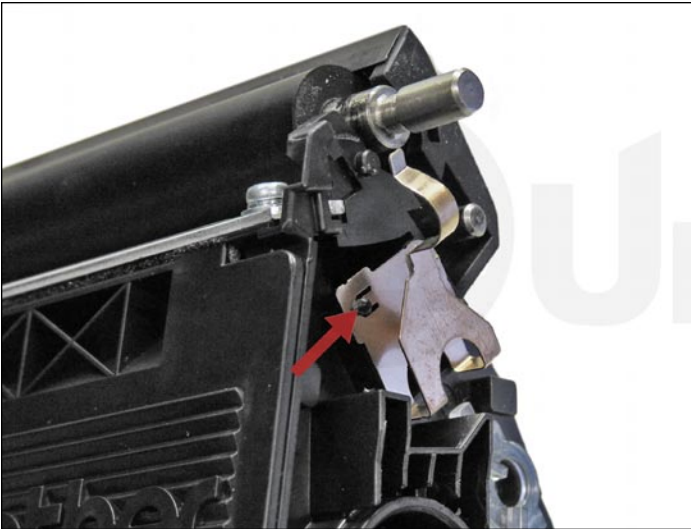

17. Install the copper contact.

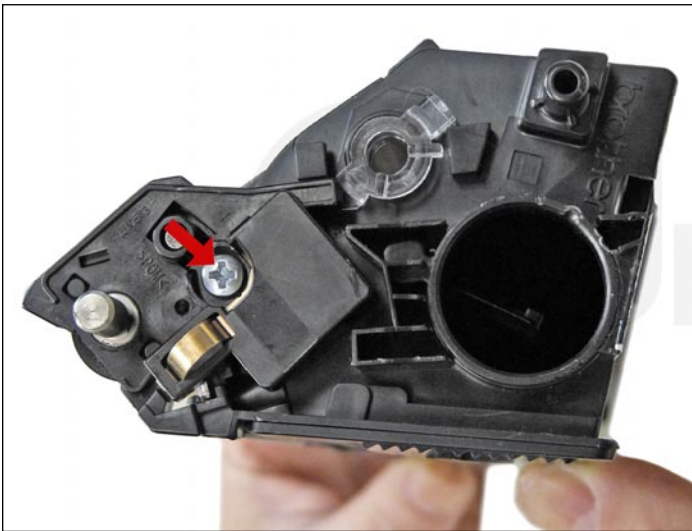

18. Install the end cap and screw.

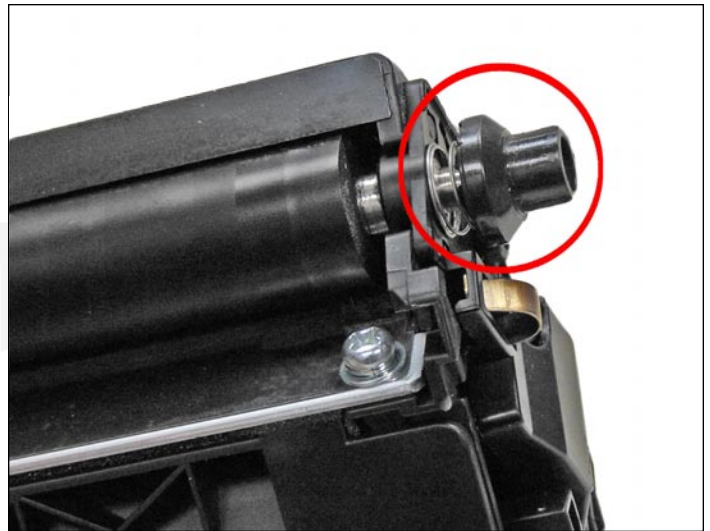

19. Install the spring and bushing.

Make sure the bushing moves freely.

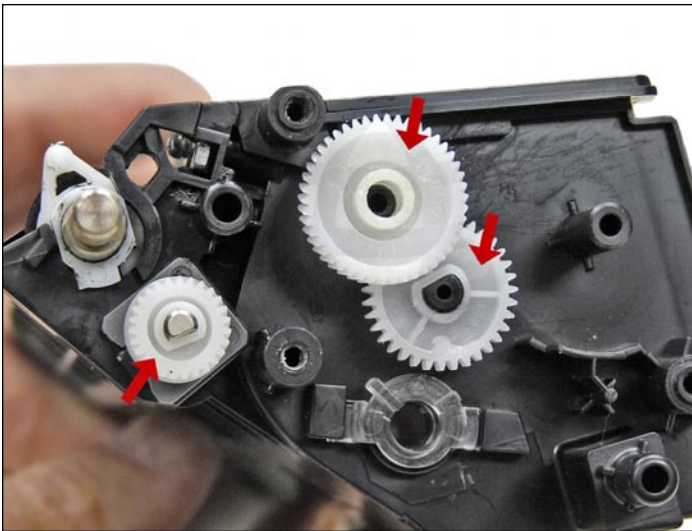

20. Clean the gears, making sure that they have no toner on them. This is a good time to also check the gear shafts to make sure there is enough grease. If the shafts appear dry, or the grease is contaminated with toner, clean the shaft and inside of the gear. Replace the grease with white lithium grease. Install the three small gears as shown.

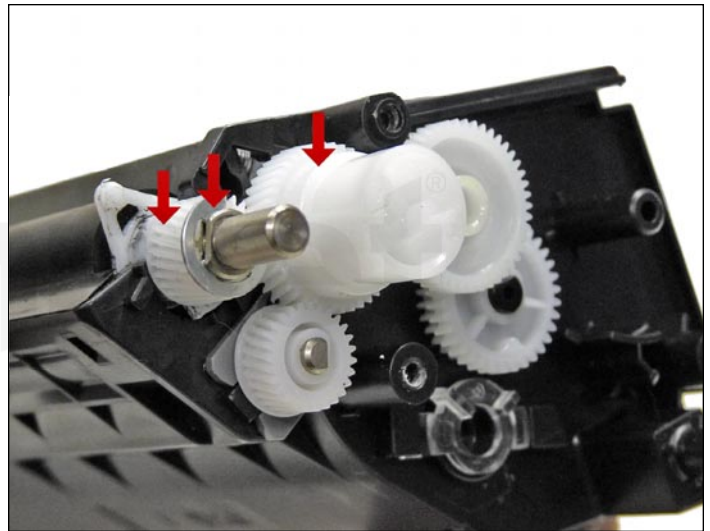

21. Install the developer roller gear and the drive gear.

Install the E-ring.



22. Turn the white magnetic roller lock down so the tab locks into the hole.

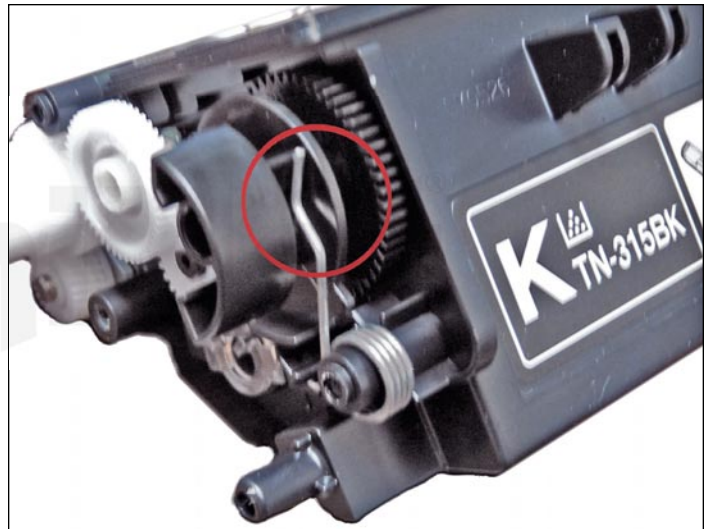
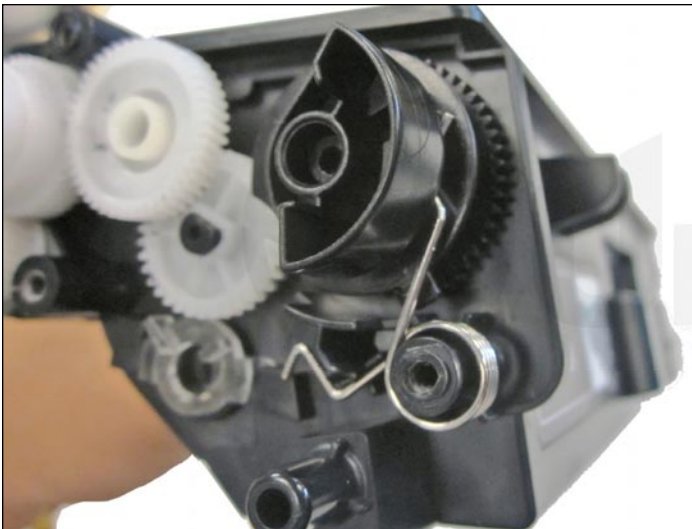

23. Set the reset gear and spring as shown. The tail of the spring fits into a notch at the base of the gear. Starter cartridges do not come with this gear, but it can be added and the starter cartridge used as a high yield or extra high yield cartridge. Shown here is the extra high yield (black) reset gear.

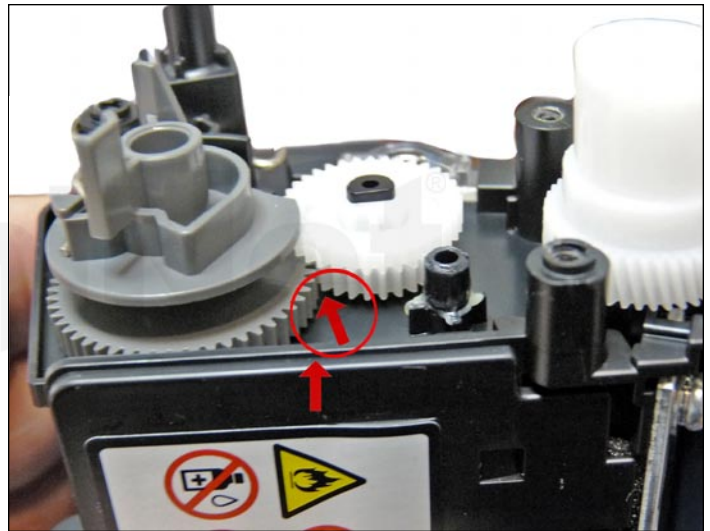
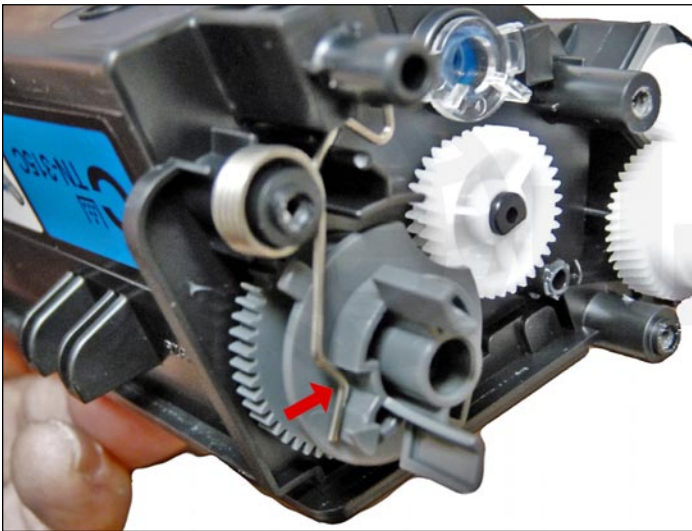

24. Shown is the high yield (gray) reset gear.



25. Install the developer roller bushing.

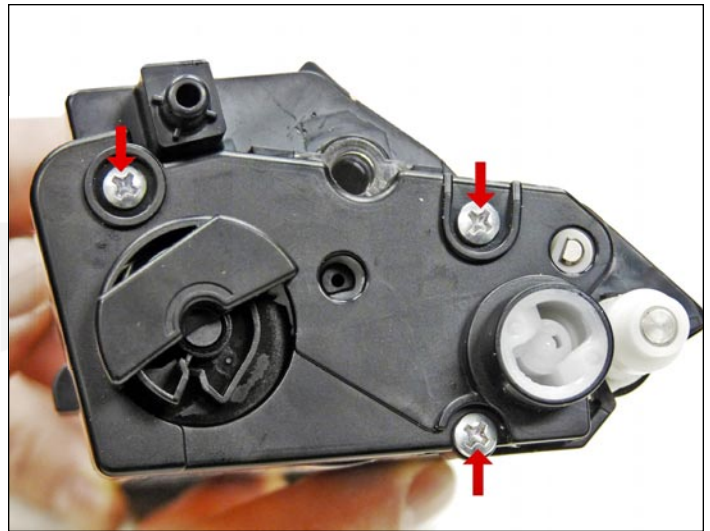

26. Install the gear-cover plate, and three screws.



27. Fill the cartridge with the appropriate color and amount of replacement toner for use in Brother HL-4150.

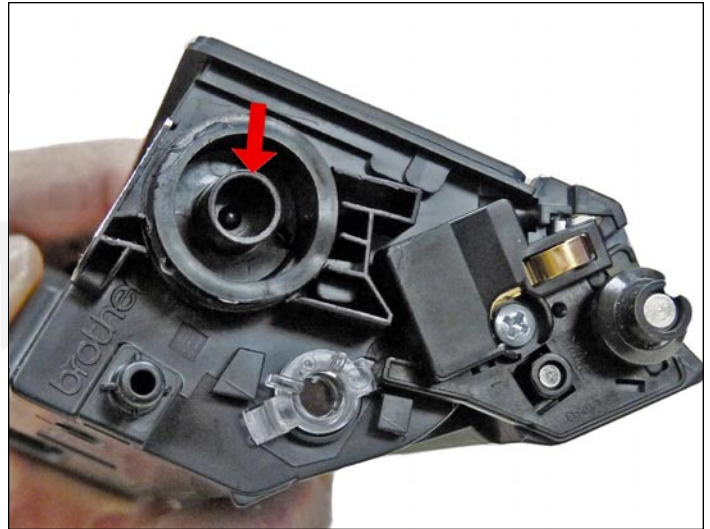

28. Replace the fill plug.

Wipe the cartridge down to remove any remaining toner dust.



29. Install the developer roller cover. This is important as the developer roller is exposed and is easily damaged or contaminated.

PRINTING TEST PAGES

Printer Setting Pages:

1. Press the OK button three times while the printer is in the READY state.
2. The printer will show "Print Settings/Printing" on the LCD display.
3. Some machines will run three pages; others will run four.

MACHINE TROUBLESHOOTING

The machine error codes are self-explanatory, so there is no need to go into them here.

RESETTING THE TONER CARTRIDGE

If for some reason a machine will not reset using a reset gear, the machine can be reset through the printer menu. This procedure should never be given to a user though, as it entails going into the service menu; and if they go into the wrong menu and press the wrong buttons, damage to the machine can and will happen. This should only be performed by qualified technicians and only if the reset gear on the cartridge does not work.

1. Open the front cover.
2. Press the SECURE and CANCEL buttons at the same time.
3. The "Reset Menu" should appear on the display.
4. Press the up or down arrows to select the cartridge you want to reset the count on.
5. Press the OK button.
6. Once the "Up Arrow Reset Down Arrow Exit" message appears on the display, press the up arrow button.
7. The developer roller counter is reset.
8. Close the front cover

NOTE: If there is no operation for 30seconds or more, the printer automatically returns to Step 1.

Here is a list of cartridges that can be reset and how they appear in the listing:

| | |
|-------------------|--|
| K.TNR-STD | Starter/standard black developer roller reset |
| K.TNR-HC | High yield black developer roller reset |
| K.TNR-S.HC | Extra high yield black developer roller reset |
| C.TNR-STD | Starter/standard cyan developer roller reset |
| C.TNR-HC | High yield cyan developer roller reset |
| C.TNR-S.HC | Extra high yield cyan developer roller reset |
| M.TNR-STD | Starter/standard magenta developer roller reset |
| M.TNR-HC | High yield magenta developer roller reset |
| M.TNR-S.HC | Extra high yield magenta developer roller reset |
| Y.TNR-STD | Starter/standard yellow developer roller reset |
| Y.TNR-HC | High yield yellow developer roller reset |
| Y.TNR-S.HC | Extra high yield yellow developer roller reset |

REPETITIVE DEFECT CHART

| | |
|-------------------------------|----------------|
| Developer roller: | 30.0 mm |
| OPC drum: | 94.0 mm |
| Upper fuser roller: | 78.5 mm |
| Lower pressure roller: | 78.5 mm |